

Specification:

Housing Material: Polycarbonate.UL Flammability Rating:

UL 94V-2,RoHS Compliant.

Contacts Type: Two prong angled pin fits solid/stranded wires.

Gold Plating: Fu"(flash)

Shielded Material: Non-Shielded

Operating Temperature: -10°C to +60°C

Housing Colour: Transparent

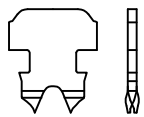
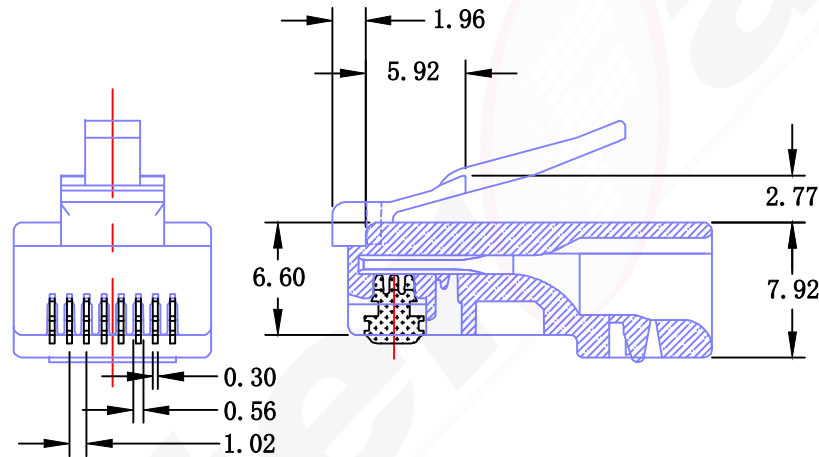
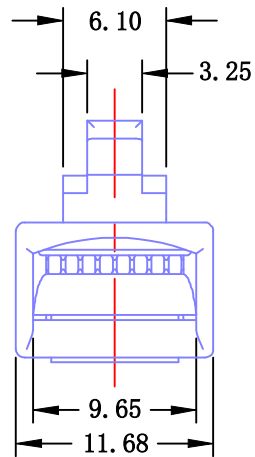

□ Two prongs pin

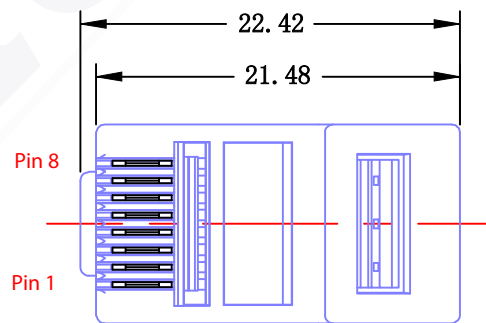

INTERFACE CONNECTRONICS PVT LTD							
Address:#85, Unit#3, 1st Floor, V.V. Yoga Saurabha, S. C. Road, Yeshwanthpur, Bangalore- 560 022.							
Product Description	Interface® RJ45 8P8C Plug, Gold Flash UL E500793						
Part no.	ICMP-88-01	Version	A0	Proportion			
Customer Code	TBA	Customer Part No.	TBA	Unit	mm		
Tolerance	X. ±0.50, X. ± 0.38, XX ± 0.25, .XXX ± 0.13			File No.	TBA		
Drawn By	NBC	Checked by	VN	Approved by	YRS	Date	12/3/2019