

Kensington®

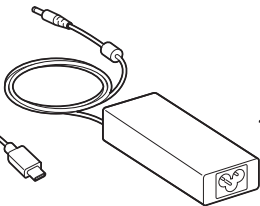

SD4800P Universal USB-C Scalable Video Dock with Power Delivery

通用 USB-C 可扩展视频扩展坞 (具备供电功能)

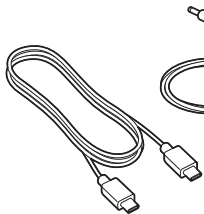

NA

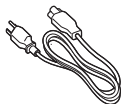

EU



AU

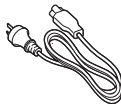

JP

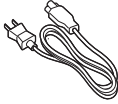



kensington.com/register

1

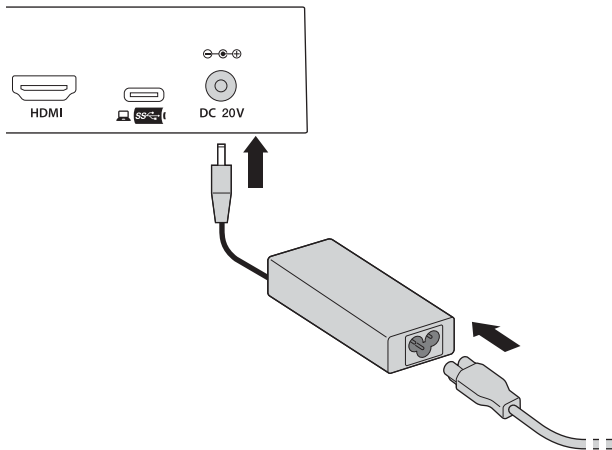

NA

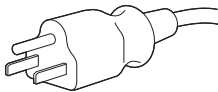

AU / 中国

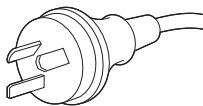

JP



EU

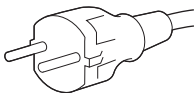
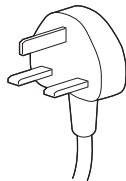
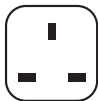

2

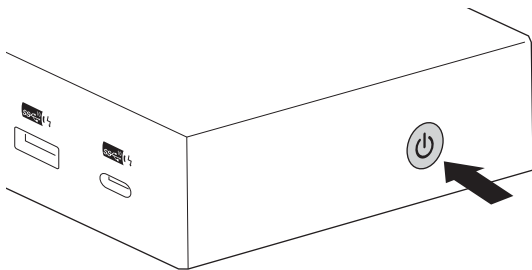

3

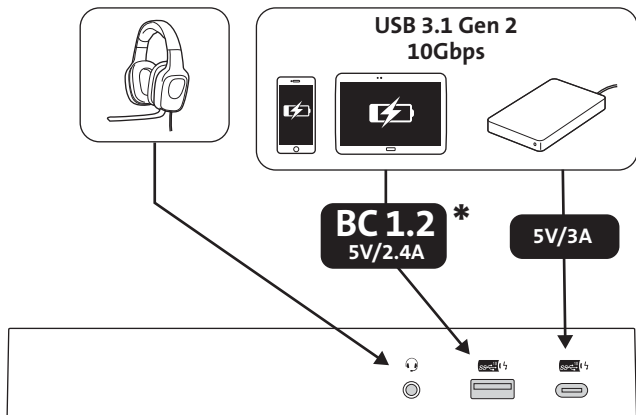

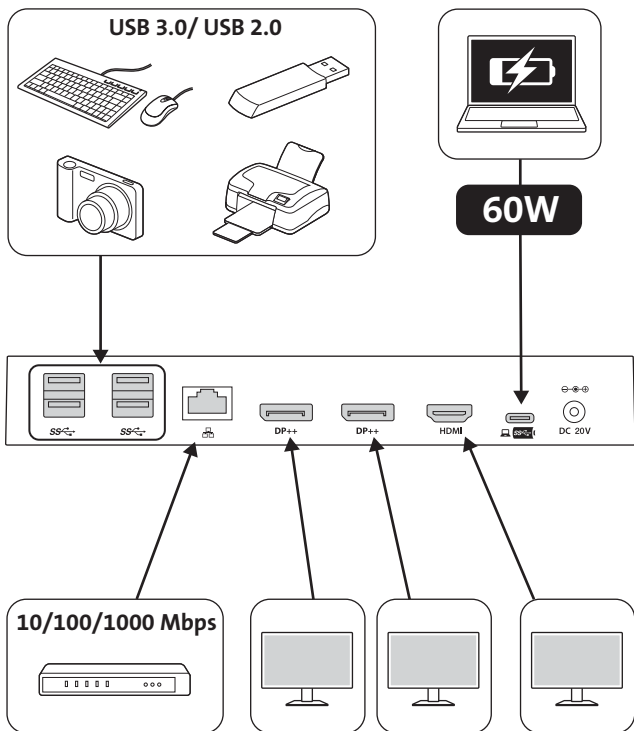

BC 1.2 *

- GB** * USB Battery Charging 1.2-compliant devices
- DE** * USB-Batterie zum Laden mit 1,2A kompatibler Geräte
- FR** * Chargeur USB 1.2 pour les appareils conformes
- NL** * Batterij opladen via USB 1.2-compatibele apparaten
- ES** * Dispositivos compatibles con el cargador USB 1.2 para baterías
- IT** * Dispositivi conformi alle specifiche USB Battery Charging 1.2
- PT** * Dispositivos de carregamento de bateria compatíveis com USB 1.2
- DK** * USB-batteri oplader 1.2-kompatible enheder
- NO** * Enheter som er kompatible med USB 1.2 batterilading
- SE** * Använd enheter kompatibla med USB-batteriladdning 1.2.
- FI** * USB-akkulaturin 1.2 kanssa yhteensopivat laitteet
- EE** * USB-akulaadimise standardiga 1.2 ühilduvad seadmed
- LV** * Ar USB akumulatoru uzlādes specifkāciju 1.2 saderīgas ierīces
- LT** * USB baterijos įkrovimas 1.2 versijos suderinamiems įrenginiams
- PL** * Urządzenia zgodne z ładowaniem USB 1.2
- CZ** * Zařízení podporující nabíjení baterií prostřednictvím rozhraní USB verze 1.2
- SK** * Zariadenia podporujúce nabíjanie batérie cez USB verzie 1.2
- HU** * USB-akkumulátortöltés 1.2-es szabványnak megfelelő eszközöknél
- RO** * Dispozitive în conformitate cu Încărcare acumuloare prin USB 1.2
- RU** * Зарядка аккумулятора USB 1.2 –совместимые устройства
- UA** * Пристрої, що відповідають Плану сумісності 1.2 для заряджання акумуляторів через USB
- KZ** * 1.2 USB батарея зарядтау пішімімен үйлесімді құрылғылар
- TR** * USB Pil Şarjı 1.2 ile uyumlu cihazlar
- GR** * Συσκευές συμβατές με φόρτισης μπαταρίας USB 1.2
- CN** * USB 电池充电 1.2 兼容设备
- JP** * USB バッテリー充電 1.2 互換機器
- AR** * الإصدار USB 1.2 أجهزة متوافقة مع شحن بطارية *

4

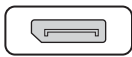

DisplayPort

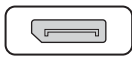

DisplayPort

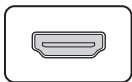
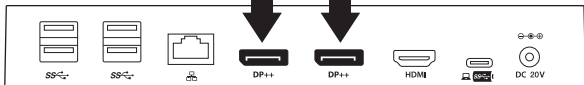

HDMI

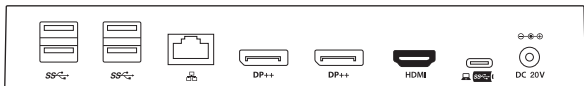

5
a

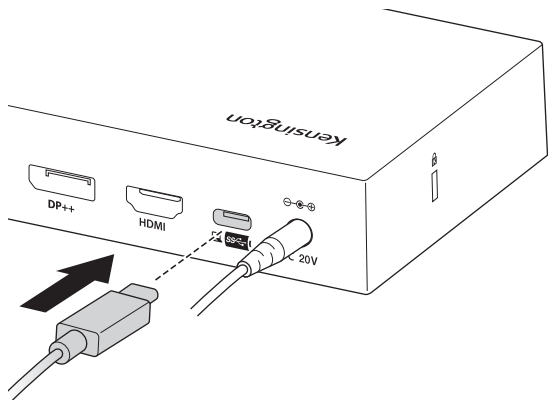

b

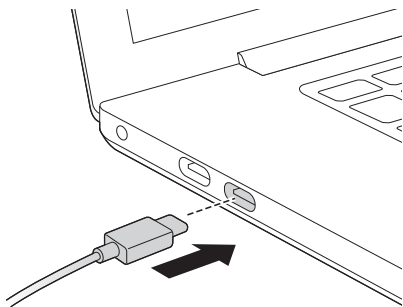

1

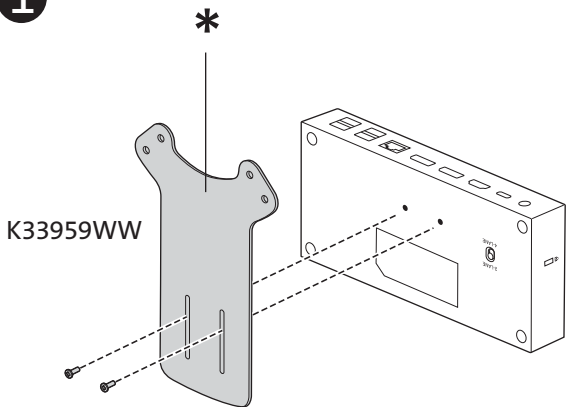

2

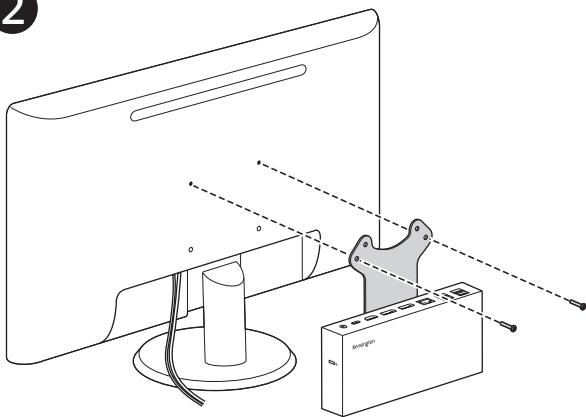

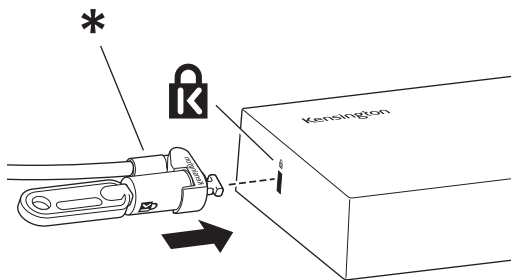

GB Recommended

DE Empfohlen

FR Recommandé

NL Recommended

ES Recomendado/a

IT Consigliato

PT Recomendado

DK Anbefales

NO Anbefalt

SE Rekommendera

FI Suositeltu

EE Soovitatud

LV Ieteicams

LT Rekomenduojama

PL Polecane

CZ Doporučeno

SK Odporúčané

HU Ajánlott

RO Recomandat

RU Рекомендуется

UA Рекомендовано

KZ Ұсынылған

TR Tavsiye edilen

GR Συνιστάται

CN 推荐

JP 推奨

AE

موصى به

K65020WW MicroSaver® 2.0 Keyed Lock

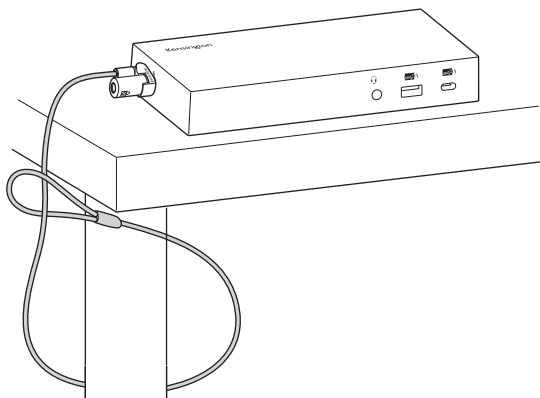

GB * Sold separately

DE * Separat erhältlich

FR * Vendu séparément

NL * Sold Separately

ES * Se vende por separado

IT * Venduto separatamente

PT * Vendido em separado

DK * Skal købes separat

NO * Selges separat

SE * Säljs separat

FI * Myydään erikseen

EE * Müüakse eraldi

LV * Iegādājams atsevišķi

LT * Įsigijama atskirai

PL * Sprzedawane oddzielnie

CZ * Prodává se samostatně

SK * Predáva sa samostatne

HU * Külön vásárolható meg

RO * Comercializat separat

RU * Продается отдельно

UA * Продається окремо

KZ * Бөлек сатылады







TR * Ayrıca Satılır





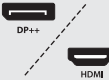

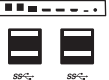
GR * Πωλείται ξεχωριστά







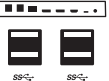

CN * 单独出售

JP * 別売

AE * يُباع بشكل منفصل*

1X 				
				
2-LANE * HBR2 (DP1.2)	2560*1440 @60HZ 3840*2160 @30HZ	USB 3.1 Gen2 (10Gbps)	USB 3.1 Gen1 (5Gbps)	1000Mbps
2-LANE * HBR3 (DP1.3)	3840*2160 @60HZ			
4-LANE ** HBR2 (DP1.2)	3840 *2160 @60HZ	USB 2.0 (480Mbps)	USB 2.0 (480Mbps)	100Mbps
4-LANE ** HBR3 (DP1.3)	3840*2160 @60HZ			

2X 				
				
2-LANE * HBR2 (DP1.2)	1920*1080 @60HZ	USB 3.1 Gen2 (10Gbps)	USB 3.1 Gen1 (5Gbps)	1000Mbps
2-LANE * HBR3 (DP1.3)	2560*1440 @60HZ			
4-LANE ** HBR2 (DP1.2)	2560*1440 @60HZ	USB 2.0 (480Mbps)	USB 2.0 (480Mbps)	100Mbps
	3840*2160 @30HZ			
4-LANE ** HBR3 (DP1.3)	2560*1600 @60HZ			
	3840*2160 @30HZ			

3X 						
	 DP++	 DP++	 HDMI			
2-LANE * HBR2 (DP1.2)	1600*900 @60HZ	1600*900 @60HZ	1600*900 @60HZ	USB 3.1 Gen2 (10Gbps)	USB 3.1 Gen1 (5Gbps)	1000Mbps
2-LANE * HBR3 (DP1.3)	1920*1080 @60HZ	1920*1080 @60HZ	1920*1080 @60HZ			
4-LANE ** HBR2 (DP1.2)	1920*1080 @60HZ	1920*1080 @60HZ	1920*1080 @60HZ	USB 2.0 (480Mbps)	USB 2.0 (480Mbps)	100Mbps
4-LANE ** HBR3 (DP1.3)	3840*2160 @30HZ	3840*2160 @30HZ	3840*2160 @30HZ			

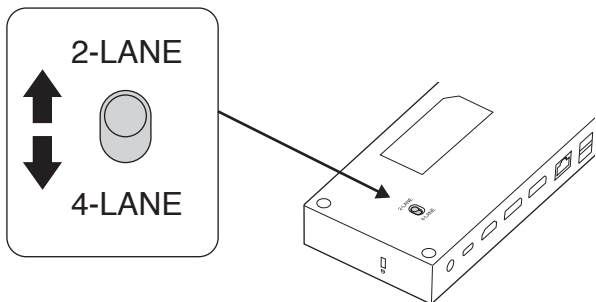

*	**
GB Default Mode	Video Boost Mode
DE Standardmodus	Video Boost-Modus
FR Mode par défaut	Mode d'optimisation vidéo
NL Standaardmodus	Videoversterkingsmodus
ES Modo predeterminado	Modo propulsión de vídeo
IT Modalità predefinita	Modalità potenziamento video
PT Modo predefinido	Modo de melhoramento de vídeo
DK Default Mode	Video Boost Mode
NO Std. modus	Videoboost-modus
SE Standardläge	Videoboostläge
FI Oletustila	Videotehotila
EE Vaikerežiim	Videovõimendusrežiim
LV Noklusējuma režīms	Video paātrinājuma režīms
LT Numatytasis režimas	Vaizdo stiprinimo režimas
PL Tryb wyświetlania	Tryb przyspieszenia wideo
CZ Výchozí režim	Režim podpory videa
SK Predvolený režim	Režim podpory videa
HU Alapértelmezett üzemmód	Video Boost mód
RO Modul implicit	Modul de amplificare video
RU Режим по умолчанию	Режим улучшения видео
UA Стандартний режим	Покращений режим відео
KZ Әдепкі режим	Видео күшейту режимі
TR Varsayılan Mod	Video Geliştirme Modu
GR Προεπιλεγμένη λειτουργία	Λειτουργία ενίσχυσης βίντεο
CN 默认模式	视频增强模式
JP デフォルトモード	ビデオブーストモード
AR الوضع الافتراضي	وضع تحسين الفيديو



www.kensington.com/support



Australia	1300 881 931	México	55 15 00 57 00
België / Belgique	02 401 2395	Nederland	010 713 1882
Brasil	14 3235-4003	New Zealand	0800 539 26273
Canada	1 800 268 3447	Norway	80017520
中国	400 0684 219	Österreich	0800 677 783
Denmark	80 250966	Polska	22 570 18 00
Deutschland	0692 222 3654	Portugal	800855802
España	911 146 735	Россия	007 495 933 5163
Finland	0800 9 15697	Schweiz / Suisse	044 580 6667
France	01 7671 0404	Singapore	+65-6776-0195
Hong Kong	00852 2823 5130	Sweden	08 5033 6577
Hungary	06 20 9430 612	United Kingdom	0203 364 5390
Ireland	01 431 1395	United States	1 800 535 4242
Italia	02 3604 7030	International Toll	+44 203 364 5390
Japan	+81 04-7129-2135		

Kensington and ACCO are registered trademarks of ACCO Brands. All other registered and unregistered trademarks are the property of their respective owners.

© 2019 Kensington Computer Products Group, a division of ACCO Brands. Any unauthorized copying, duplicating, or other reproduction of the contents hereof is prohibited without written consent from Kensington Computer Products Group. All rights reserved. 02/19



Kensington Computer Products Group
A Division of ACCO Brands
1500 Fashion Island Blvd, 3rd Floor
San Mateo, CA 94404



ACCO Brands Europe

A Division of ACCO Brands Europe
Oxford House, Oxford Road
Aylesbury, Buckinghamshire,
HP21 8SZ United Kingdom

ACCO Brands Canada Inc

7381 Bramalea Rd
Mississauga,
ON L5S 1C4
Canada

ACCO Brands Australia - Kensington

2 Coronation Avenue
Kings Park NSW 2148
Australia

Importado por ACCO Mexicana S.A. de C.V.

Circuito de la Industria Norte # 6,
Corredor Industrial Toluca Lerma,
Lerma México Cp. 52004
R.F.C. AME640229-1W3

Acco Brands Chile S.A.,

Avda. Presidente Riesco # 5711,
oficina 201
Las Condes, Santiago,
Chile C.P. 7561114

Importado e Distribuído por:

Tilibra Produtos De Papelaria Ltda.
CNPJ: 44.990.901/0001-43
Rua Aymorés, 6-9 – Bauru/SP –
Brasil CEP 17013-900

LEITZ ACCO Brands GmbH & Co KG

Siemensstraße 64
70469 Stuttgart
Germany

Dystrybutor:

Esselte Polska Sp. z o.o., ul.
Przemysłowa 11A,
26-900 Koźienice

Dovozce/Dovozca:

Esselte, s.r.o., V Lužich 818,
142 00 Praha 4,
Česka republika

Forgalmazza:

Esselte Kft, Vaci ut 76. V. torony I.
emelet,
1133 Budapest,
Magyarország

Importator:

Esselte Sales SRL, Gheorghe
Țițeica 121C,
Sector 2, București,
Romania

Дистрибутор:

Есселте Польска Сп. з о.о.,
вулиця Пшемислова, 11А,
26-900 Коженіце
Товар не підлягає обов'язковій
сертифікації.
Термін придатності необмежений.

Импортер:

ООО "Эсселте", Россия, 125040,
Москва, 3-я улица Ямского поля,
д.18, тел.
+7(495)933-27-63
Товар не подлежит обязательной
сертификации.
Срок годности не ограничен.

Өндіруші:

"Esselte Polska Sp. z o.o.", ul.
Przemysłowa 11A, 26-900 Koźienice
Импорртаушы: "АБДИ Компани"
АҚ, Алматы қ., Сейфуллин даңғ.
465/191"
Тауар міндетті сертификаттауды
қажет етпейді.
Жарамдылық мерзімі шектелмеген.

ACCO Brands Asia Pte Ltd

5A Toh Guan Road East #06-03,
Singapore 608830

广州市爱珂贸易有限公司

上海分公司

中国上海市长宁区

延安西路2299号1509室

电话: 021-61368966

传真: 021-61710161

www.accobrand.cn

アコ・ブランド・ジャパン株式会社

〒164-8721

東京都中野区本町1-32-2

ハーモニータワー14F

http://www.kensington.com/jp

E-MAIL: JP.Kensington@acco.com

Designed in California, U.S.A.

by Kensington

www.kensington.com

Made in China | Fabriqué en Chine | Fatta in Cina | Hecho en China | Fabricado em China | Κατασκευάζεται στην Κίνα |
Számazási ország Kína | Fabricat in China | Сделано в Китае | Зроблено в Китаї | Қытайда өндірілген | صنع في الصين